

SCALE AEROBATIC GLIDER

MDM 1

EX



Manufactured by:

**TOPMODEL CZ**

679 05 HABRŮVKA 100 - CZECH REPUBLIC

www.topmodelcz.cz

e-mail: info@topmodelcz.cz

Order N°: 02081

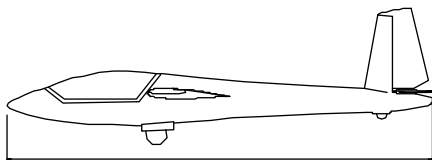

2130mm

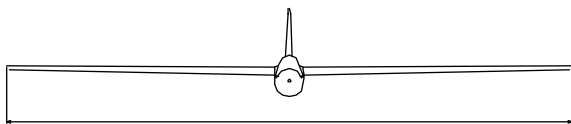

4000mm

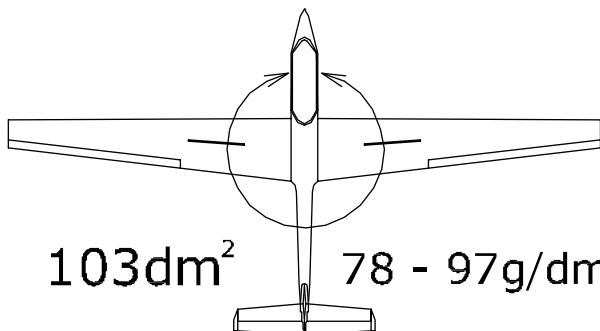

103dm<sup>2</sup>

78 - 97g/dm<sup>2</sup>

Radio system you'll need :

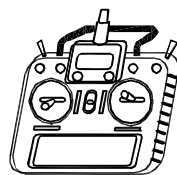

6 channel  
with  
8-9 servos



8 - 10kg



HQ 2,0-12/2,0-10

Není-li uvedeno jinak, všechny  
neoznačené míry jsou v milimetrech  
UNLES STATED, ALL DIMENSIONS  
ARE IN MILIMETERS

Part #	Part name	Material, dimensions	Loose	In bag
	building instructions		01	-
	drawing documetation		01	-
1	fuselage	fiberglass	01	-
1-23	elevator servo tray	plywood 4 mm 42 x 65 mm	-	01
2	wing	foam core-abachi Oracover@covered	02	-
2-1	aileron	foam core-abachi Oracover@covered	02	
2-11	flap	foam core-abachi Oracover@covered	02	
(2-21)	centering pin	(installed)	-	-
2-3	wing fixing	plastic part	-	02
2-4	servo wing mount	polyurethan- 20mm	-	14
2-41	wing servo cover	ABS	-	04
2-4a	airbrake servo top	sticker $\phi$ 60mm	-	02
2-5	aileron-flap pushrod	M3 L = 57mm	-	04
2-6	clevis	metal M3, nut M3	-	08+08
2-8	aileron control horn	fiberglass	-	02
2-81	flap control horn	fiberglass	-	02
(2-9)	airbrake pushrod	(installed)	-	-
24	wing joiner	steel $\phi$ 20 mm x 600 mm	01	-
3	horizontal stabilizer	fiberglass	01	-
3-4	stabilizer fixing screw	M5 x 20mm, M5 x 25mm	-	01+01
3-5	elevator pushrod	M3 L = 65mm	-	01
3-6	clevis	metal M3, nut M3, ball link M3, screw M3x10, washer	-	01+01+01 +01+01
3-8	elevator control horn	fiberglass 2 mm	-	02
(4)	rudder	fiberglass	01	-
4-1	rudder cover	fiberglass	01	-
4-5	rudder pushrod	M3 L = 55mm	-	01
4-6	clevis	metal M3, nut M3	-	02+02
4-8	rudder control horn	MPJ 2290	-	01
(10)	retract gear	(installed)	-	-
(10-3)	tailwheel	(installed)	-	-
5	canopy frame	fiberglass	02	-
6	canopy	PVC	01	-
6-1	canopy hinge	MPJ	-	04
6-11	hinge fixing	wood screw $\phi$ 2,9x9 ( flush head )	-	08
6-2	hatch latch	aluminium	-	02
6-21	pivot	M3 x 20 mm	-	02
6-22	spindle	M2 x 8 mm	-	02
7	stickers		-	07

**SERVOS:**

aileron - 4x standard servo ( 6 – 8kg )  
elevator – 1x standard servo ( 8 – 10kg )  
rudder – 1x standard servo ( 6 – 8kg )  
airbrake - 2x micro servo

**ATTENTION !!!**

This model construction kit is not a toy and is not suitable for children under the age of 14.

Incorrect use of this model could cause material damage or personal injury. You are fully responsible for your actions when you use this model.

Fly at a safe distance from occupied zones. Before switching on the radio, be sure, that no one else is using the same frequency as you!

# MDM 1 FOX

## 02081

Položka	Název dílu	Materiál, rozměr	Volně / ks	Balíček/ ks
	výkresová dokumentace		01	-
	montážní návod		01	-
1	trup	laminát	01	-
1-23	držák serva VOP	překližka 4 mm 42 x 65 mm	-	01
2	křídlo kompletní	polystyren - dýha	02	-
2-1	křídélko	polystyren - dýha	02	-
2-11	vztlaková klapka	polystyren - dýha	02	-
2-21	aretační kolík	( namontováno )	-	-
2-3	zajištění křídla	plast	-	02
2-4	držák serva	polyuretan – 20mm	-	14
2-41	krytka serva	ABS	-	04
2-4a	krytka serva brzdících štítů	samolepka $\phi$ 60mm	-	02
2-5	táhlo křídélka a klapky	M3 L = 57mm	-	04
2-6	koncovka táhla	kovová M3, matice M3	-	08+08
2-8	páka křídélka	sklotextit	-	02
2-81	páka klapky	sklotextit	-	02
(2-9)	táhlo brzdících štítů	( namontováno )		
24	spojka křídla	ocel $\phi$ 20 mm x 600 mm	01	-
3	výškovka	laminát	01	-
3-4	uchycení výškovky	šroub M5 x 20mm, M5 x 25mm	-	01+01
3-5	táhlo výškovky	M3 L = 65mm	-	01
3-6	koncovka táhla	kovová M3, matice M3, kulový čep M3, šroub M3x10, podložka	-	01+01+01 +01+01
3-8	páka VOP	sklotextit 2 mm	-	02
(4)	směrovka	laminát	01	-
4-1	krytka	laminát	01	-
4-5	táhlo směrovky	M3 L = 55mm	-	01
4-6	koncovka táhla	kovová M3, matice M3	-	02+02
4-8	páka SOP	MPJ 2290	-	01
(10)	podvozek kompletní	( namontováno )		
(10-3)	ostruha kompletní	( namontováno )		
5	rám kabiny	laminát	02	-
6	kabina	plast	01	-
6-1	závěs kabiny	MPJ	-	04
6-11	zajištění závěsu	vrut $\phi$ 2,9x9 ( zapuštěná hlava )	-	08
6-2	uzávěr kabiny	Al.	-	02
6-21	čep uzávěru	M3 x 20	-	02
6-22	hřídel uzávěru	M2 x 8	-	02
7	obtisky			07

### Potřebná serva:

křídélka - 4 standard serva 6 – 8kg  
výškovka - 1 standard servo, 8 - 10kg  
směrovka - 1 servo standard, 6 – 8kg  
brzdící štíty - 2 mikro serva

### UPOZORNĚNÍ :

Tato stavebnice není hračka – není vhodná pro děti do 14 let.  
Její nesprávné použití může způsobit materiální škody nebo zranění osob.  
Při užívání modelu jste plně zodpovědní za případné škody.  
Létejte v bezpečné vzdálenosti od obydlených oblastí.  
Ujistěte se, že nikdo jiný nemá zapnutou stejnou frekvenci.

### DŮLEŽITÉ !

I když je tento model vybaven systémem pro zajištění pevného spojení křídla s trupem, je nutné jeho další zajištění lepicí páskou, protože v případě vysunutí křídla dojde k rozpojení konektorů serv v křídle a následné havárii modelu!



# MDM 1

© VI. 2009 TOPMODEL CZ Manufactured by TOPMODEL CZ s.r.o. 679 05 HABRŮVKA 100 - Better made in the Czech Republic  
www.topmodelcz.cz e-mail: info@topmodelcz.cz

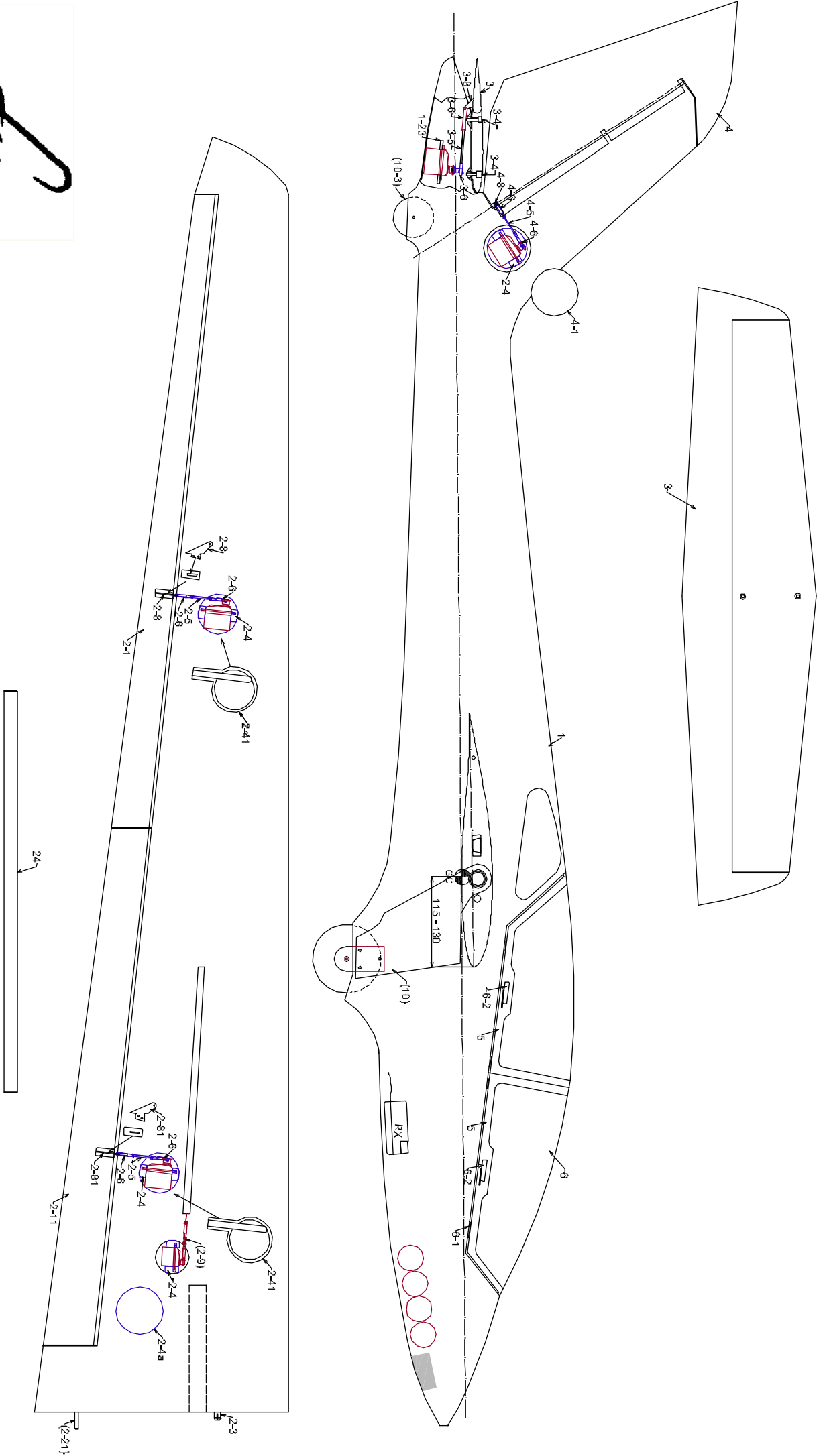

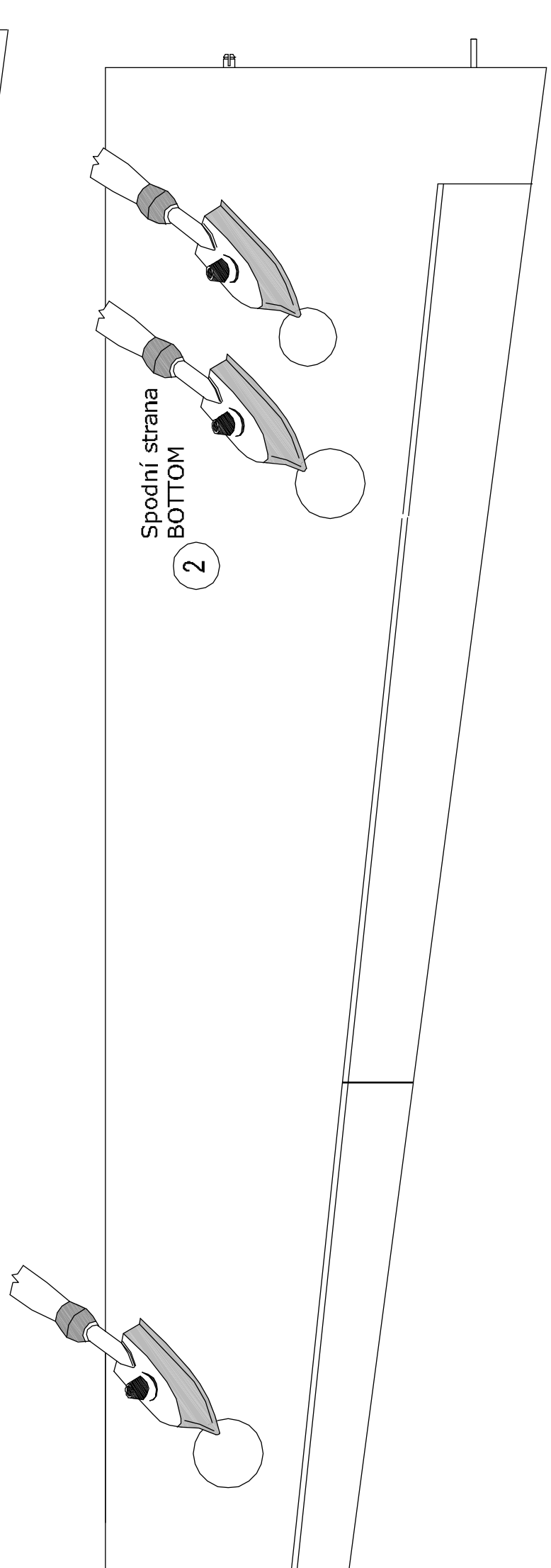
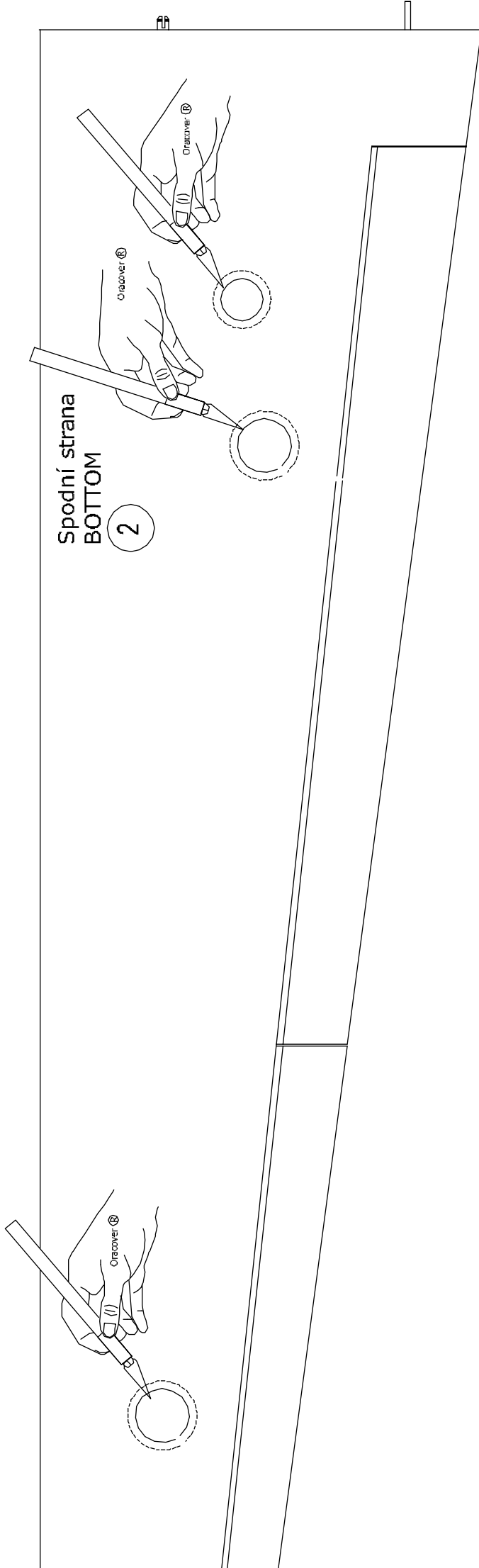

2

Ø10 pro 2-3  
for 2-3

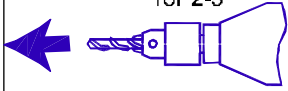

2

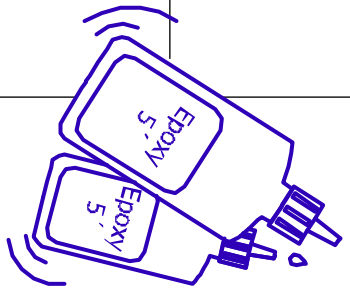

pro servo křidélek ~1200mm  
for aileron servo  
pro servo klapek ~360mm  
for flaps servo  
pro servo brzd ~250mm  
for airbrakes servo

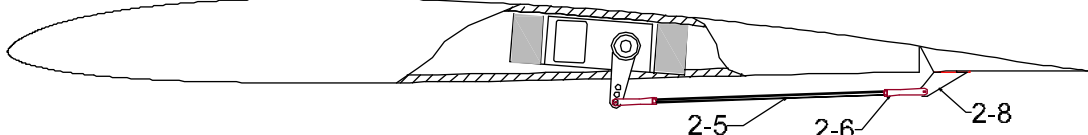
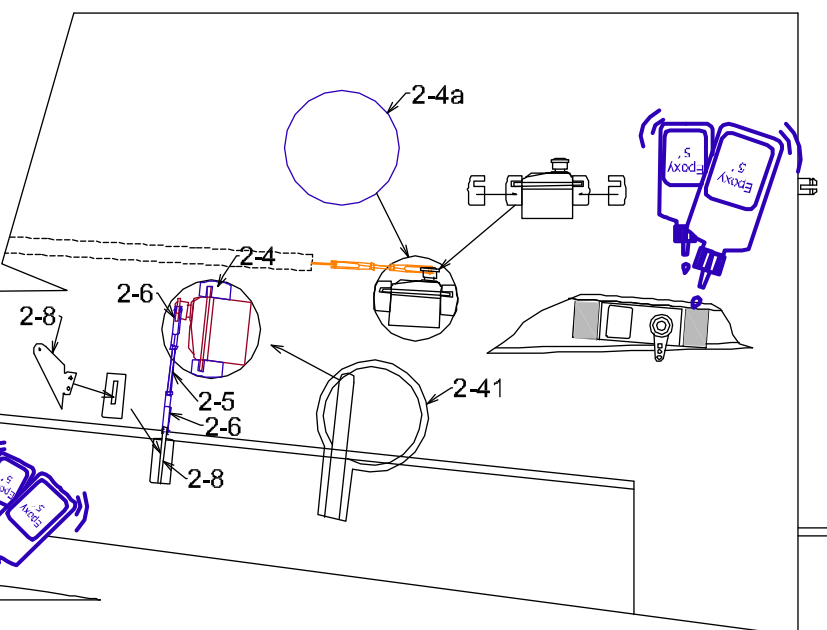
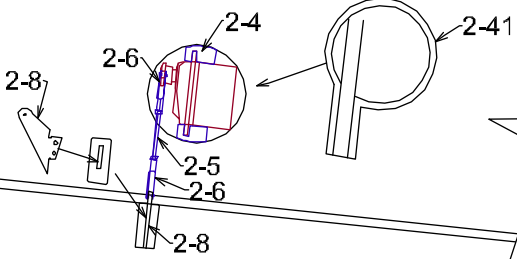
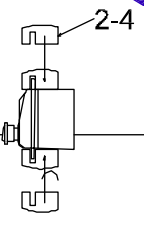
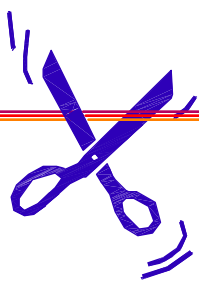
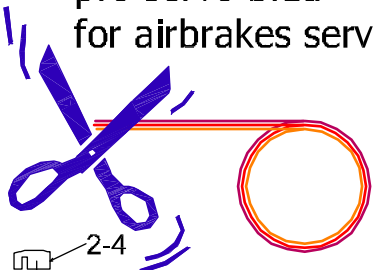

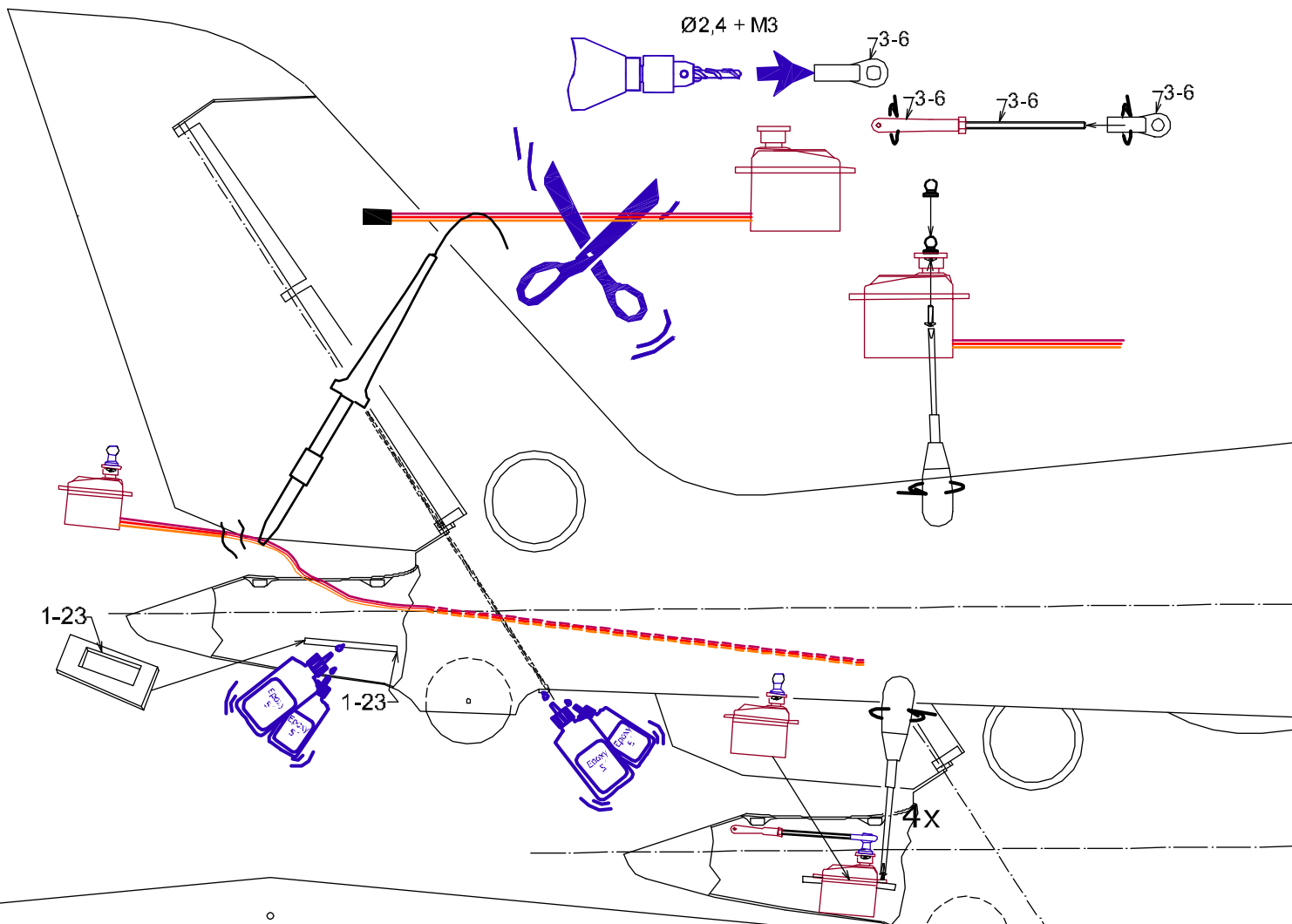

Spodní strana  
BOTTOM

Ø2 pro 3-8  
for 3-8

Spodní strana  
BOTTOM

