

ELECTRO SAILPLANE

Pegasus 2 M



Order N°: 02090.2

Manufactured by:

TOPMODEL CZ

679 05 HABRŮVKA 100 - CZECH REPUBLIC

www.topmodelcz.cz

e-mail: info@topmodelcz.cz

Radio system you'll need :

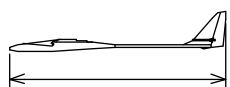

1095mm

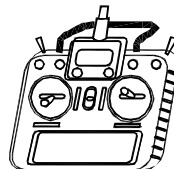

5channel
with
5 servos

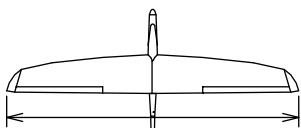

1999mm

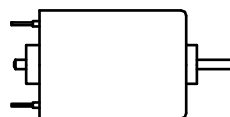

Speed 400 + 3,8:1
MEGA RC F5-J

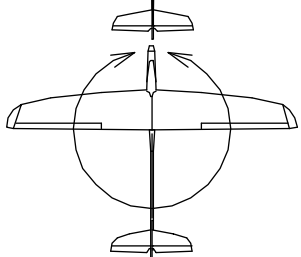

34,8dm²

17,2-21,6g/dm²



7 Nixx 0,5 - 1,1Ah
2S Lixx 1,5 - 2Ah



0,6 - 0,75 kg



AG

Není-li uvedeno jinak, všechny
neoznačené míry jsou v milimetrech
UNLES STATED, ALL DIMENSIONS
ARE IN MILIMETERS

Part #	Part name	Material, dimensions	Loose	In bag
	building instruction		01	-
1A	fuselage front part	fibreglass	01	-
1B	fuselage tube	carbon tube	01	
1-1	engine mount	fibreglass 2 mm	-	01
1-2	servo tray rudder + elevator	plywood 4 x 33 x 65 mm	-	01
1-6	tail skid	fibreglass 1 mm	-	01
2	wing	balsa assembly	02	-
2-1	aileron	balsa	02	-
2-11	flap	balsa	02	-
2-11A	flaps coupler	fibreglass Ø 2 x 20 mm	-	01
24	wing joiner	Al/carbon Ø 7 x 160 mm	-	01
2-2	wing fixing screw	nylon screw M 4 x 15 mm	-	02
2-21	centering pin	fibreglass Ø 2 x 20 mm	-	01
2-3	captive nut	M4	-	02
2-31	nut mount	plywood 3 x 25 x 31 mm	-	01
2-41	wing servo cover	ABS plastic	-	02
2-5	aileron pushrod	piano wire M2 x 31 mm	-	02
2-51	flap pushrod	piano wire M2 x 31 mm	-	01
2-6	clevis	MPJ 2100	-	04
2-61	flap clevis	MPJ 2140, nut M2, MPJ2406	-	01+01+01
2-8	aileron horn	fibreglass plate 1 mm	-	02
2-81	flap horn	fibreglass plate 1 mm	-	01
3	horizontal stabilizer	balsa assembly	01	-
3-5	elevator link	bowden Ø2 mm L=760mm, piano wire Ø0,8 mm L= 820mm	01+01	-
3-6	thread coupler	MPJ 2014	-	01
3-7	clevis	MPJ 2100	-	01
3-8	elevator horn	fibreglass plate 1 mm	-	01
4	vertical tail	balsa assembly	01	-
4-5	rudder link	bowden Ø2 mm L=720mm, piano wire Ø0,8 mm L= 760mm	01+01	-
4-6	thread coupler	MPJ 2014	-	01
4-7	clevis	MPJ 2100	-	01
4-8	rudder horn	fibreglass 1 mm	-	01
5	fuselage servo cover	fibreglass	01	-
6	canopy	fibreglass	01	-
6-1	canopy fixing	fibreglass Ø 2x20 mm, plywood 1,5x6x10, Velcro 12x20mm	-	01+01+01
7	stickers		01	

RECOMMENDED EQUIPMENT:

Radio : 5 channel + 7 channel (receiver)

Servos : Ailerons – 2 x [Dymond D47](#)

Flaps – 1 x [HS-65MG](#)

Elevator – 1 x [HS-55](#)

Rudder – 1 x [HS-55](#)

Motor : [MEGA RC F5-J](#)

Controller: JETI [SPIN 33](#)

Spinner: [Turbo 36/3,17/8](#) ø 36/3,17 mm, for blade root width 8 mm

Folding propeller blades: [CAM CARBON 10/6"](#)

Battery: **2S LiPo – 1,5 – 1,7Ah**

2 x [Flat extension cable 15cm](#) ;

[Twisted cable - thin](#) – cca 1,2 m

[Thermo-Shrinkable insulation](#) Ø 1,6 mm – cca 0,2 m.

ATTENTION!

This modelconstruction kit is not a toy and is not suitable for children under the age of 14.

Incorrect use of this model could cause material damage or personal injury.

You are fully responsible for your actions when you use this model.

Fly at a safe distance from occupied zones.

Before switching on the radio, be sure, that no one else is using the same frequency as you !

Before first take-off check up please the center of gravity, the sense and size of

the control surface angle and if model aeroplane parts aren't crooked.

The reparation is possible through the use of hot-air dryer.

Pegasus

Položka	Název dílu	Materiál, rozměr	Volně / ks	Balíček/ ks
	montážní návod		01	-
1A	trup gondola	laminát	01	-
1B	nosník ocasních ploch	uhlík	01	
1-1	motorová přepážka	sklotextit 2 mm	-	01
1-2	držák serva SOP + VOP	překližka 4 x 33 x 65 mm	-	01
1-6	ostruha	sklotextit 1	-	01
2	křídlo	balsa konstrukční	02	-
2-1	křídélko	balsa	02	-
2-11	vztlaková klapka	balsa	02	-
2-11A	spojka klapky	laminát Ø 2 x 20 mm	-	01
24	spojka křídla	AL/uhlík Ø 7 x 160 mm	-	01
2-2	uchycení křídla	šroub polyamid M 4 x 15 mm	-	02
2-21	aretační kolík	laminát Ø 2 x 20 mm	-	01
2-3	uchycení křídla	matice AL. M4	-	02
2-31	podložka matice	překližka 3 x 25 x 31	-	01
2-41	krytka serva	ABS folie	-	02
2-5	táhlo křídélka	ocel M2 x 31	-	02
2-51	táhlo klapky	ocel M2 x 31	-	01
2-6	koncovka táhla křidélek	MPJ 2100	-	04
2-61	koncovka táhla	MPJ 2140, matice M2, MPJ 2406	-	01+01+01
2-8	páka křídélka	sklotextit 1 mm	-	02
2-81	páka klapky	sklotextit 1 mm	-	01
3	výškovka	balsa konstrukční	01	-
3-5	táhlo výškovky	bowden Ø2 mm L=730mm, ocel drát Ø0,8 mm L= 790mm	01+01	-
3-6	spojka táhla	MPJ 2014	-	01
3-7	koncovka táhla	MPJ 2100	-	01
3-8	páka výškovky	sklotextit 1 mm	-	01
4	směrovka	konstrukční - balsa	01	-
4-5	táhlo směrovky	bowden Ø2 mm L=690mm, ocel drát Ø0,8 mm L= 730mm	01+01	-
4-6	spojka táhla	MPJ 2014	-	01
4-7	koncovka táhla	MPJ 2100	-	01
4-8	páka směrovky	sklotextit 1 mm	-	01
5	krytka trupu	laminát	01	-
6	kabina	laminát	01	-
6-1	uchycení kabiny	laminát Ø 2x20 mm, překližka 1,5x6x10 suchý zip 20x12 mm	-	01+01+01
7	obtisky			

DOPORUČENÉ PŘÍSLUŠENSTVÍ:

RC souprava : 5 kanál + 7 kanál přijímač

Serva : křídélka – 2x [Dymond D47](#)

klapky - 1x [HS-65MG](#)

směrovka - 1x [HS-55](#)

výškovka - 1x [HS-55](#)

Motor : [MEGA RC F5-J](#)

Regulátor: JETI [SPIN 33](#)

Akumulátory: 2S LiPo 1,5 – 1,7Ah

Kužel: [TURBO 36/3,17/8](#)

Listy: [CAM CARBON 10/6"](#)

Další příslušenství: [Prodlužovací kabel plochý 15cm NEW](#) – 2x; [Kabel kroucený tenký](#) – cca 1,2m; [Teplem smršťitelná bužírka](#) Ø 1,6mm – cca 0,2m

Před prvním startem zkontrolujte jestli nejsou díly modelu zkroucené.

Náprava je možná pomocí horkovzdušné pistole.

Dále zkontrolujte polohu těžiště, smysl a velikost výchylek kormidel.

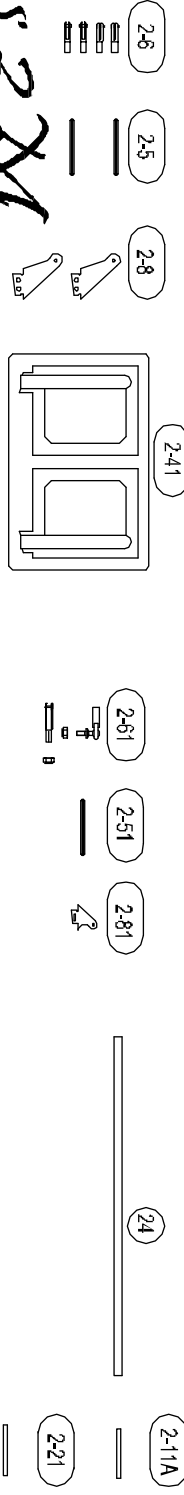
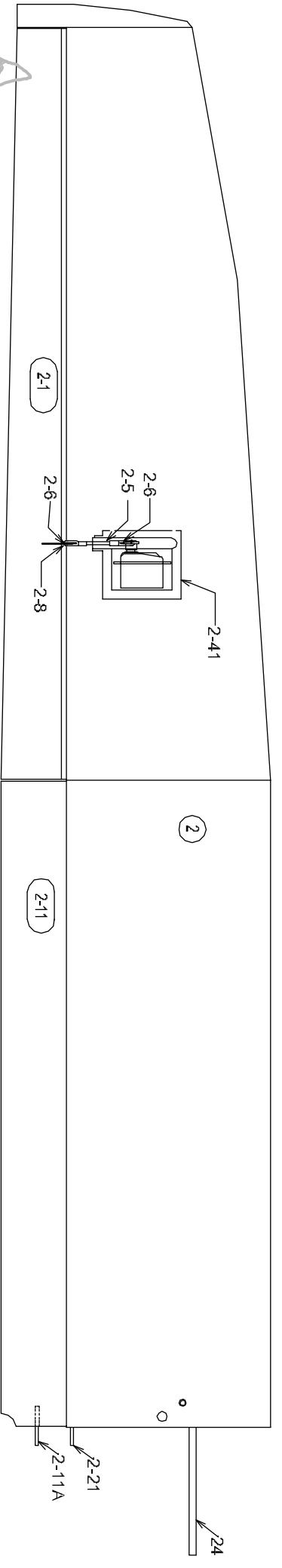
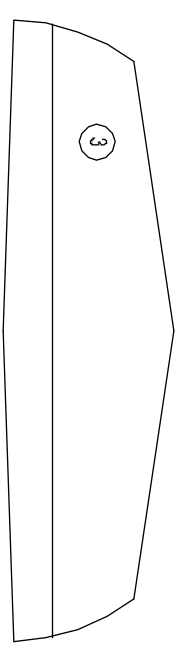
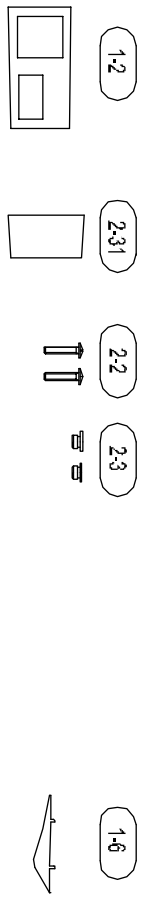
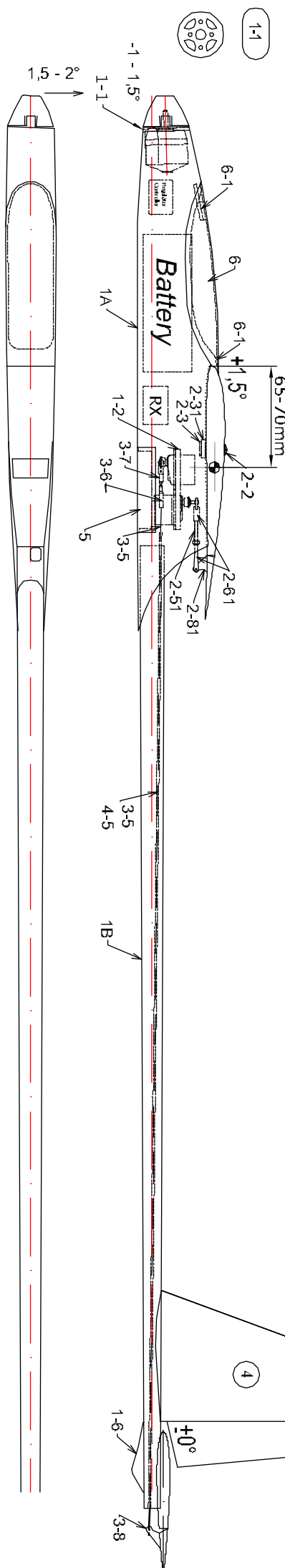
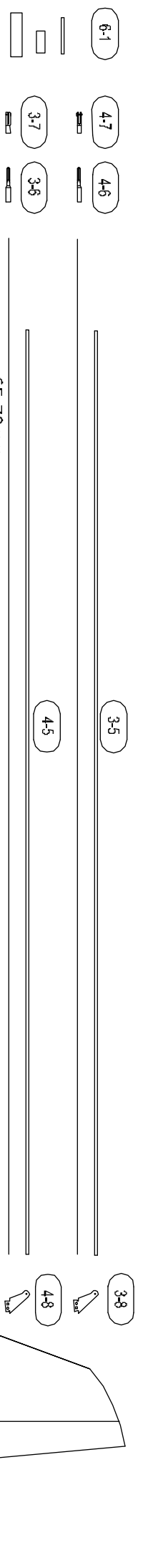

Pegasus 2 X1

© V. 2011 TOPMODEL CZ www.topmodel.cz e-mail: info@topmodel.cz
 Manufactured by TOPMODEL CZ s.r.o. 679 05 HABRŮVKA 100 - Better made in the Czech Republic

Pegasus

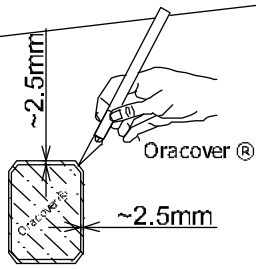

②
SPODNÍ STRANA
BOTTOM

spodní + horní strana
bottom + top

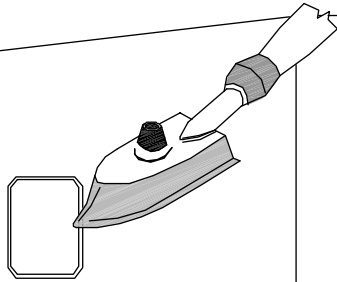
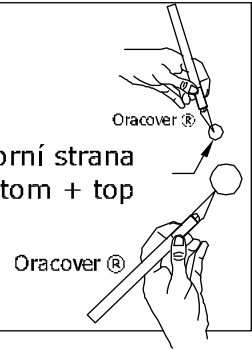

②
SPODNÍ STRANA
BOTTOM

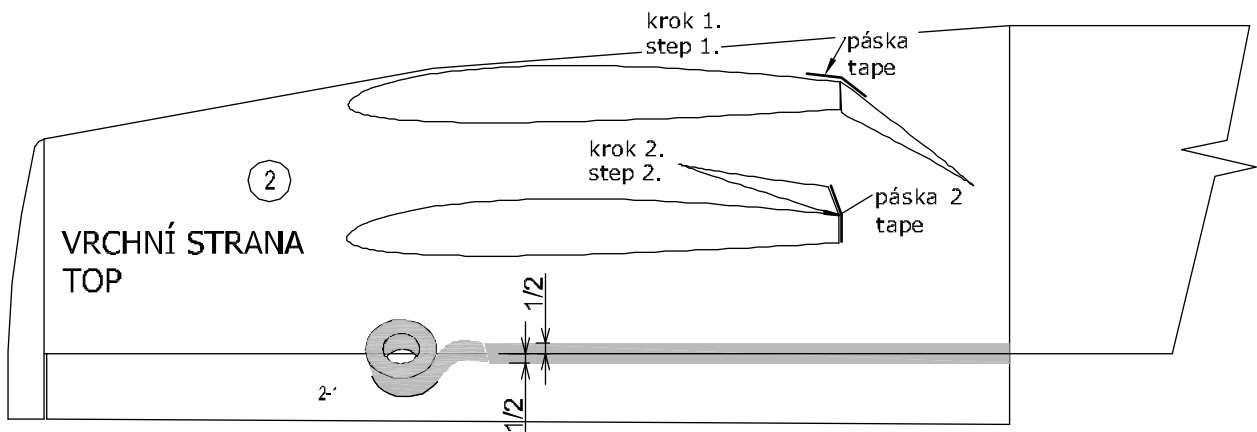

②
VRCHNÍ STRANA
TOP

krok 1.
step 1.

páska 1.
tape

krok 2.
step 2.

páska 2.
tape

2

1/2
1/2

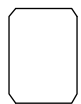

②
SPODNÍ STRANA
BOTTOM

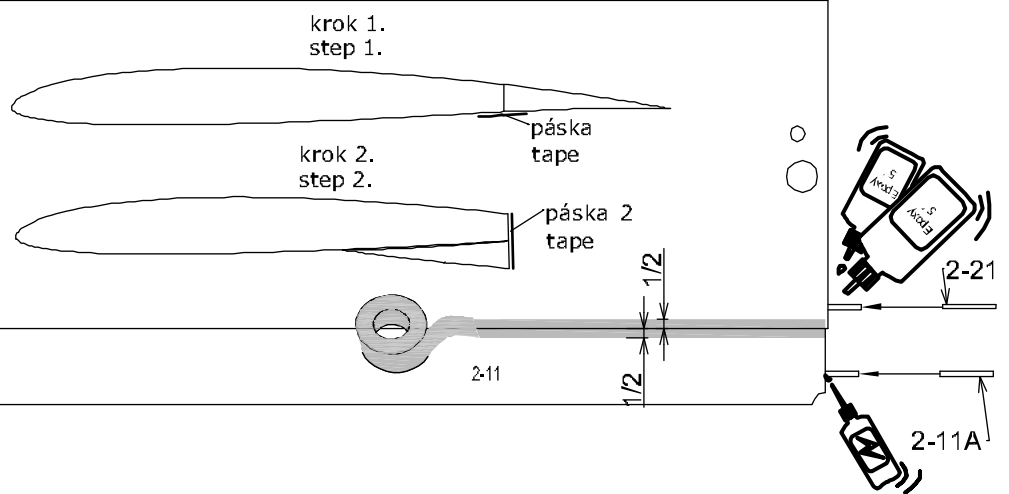

krok 1.
step 1.

páska 1.
tape

krok 2.
step 2.

páska 2.
tape

②

2-11

1/2
1/2

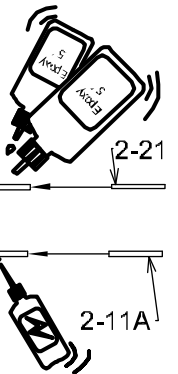

2-21

2-11A

Pegasus

pro servo křídélek ~ 700mm
for aileron servo

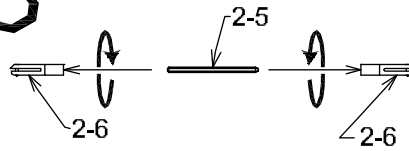
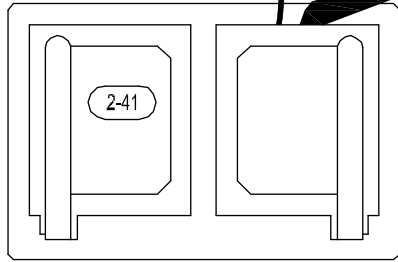
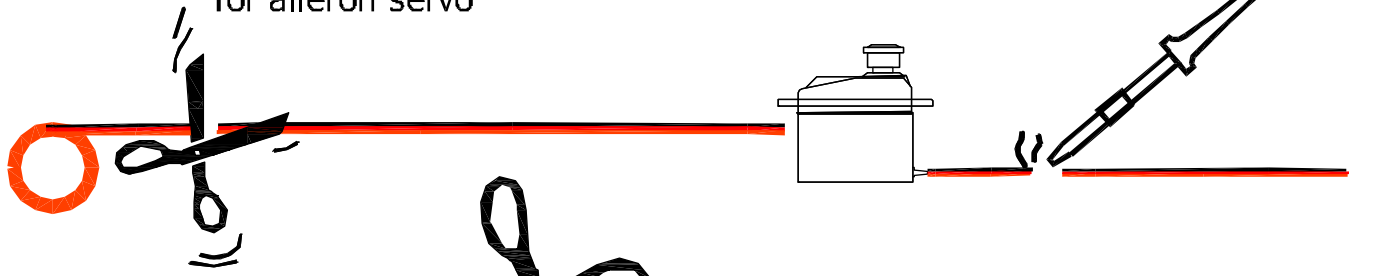

pro servo křídélek
for aileron servo

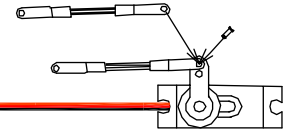

kontaktní lepidlo (Chemopren)
dry-bond adhesive

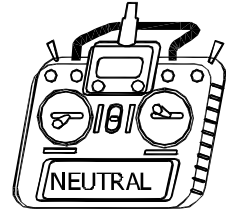
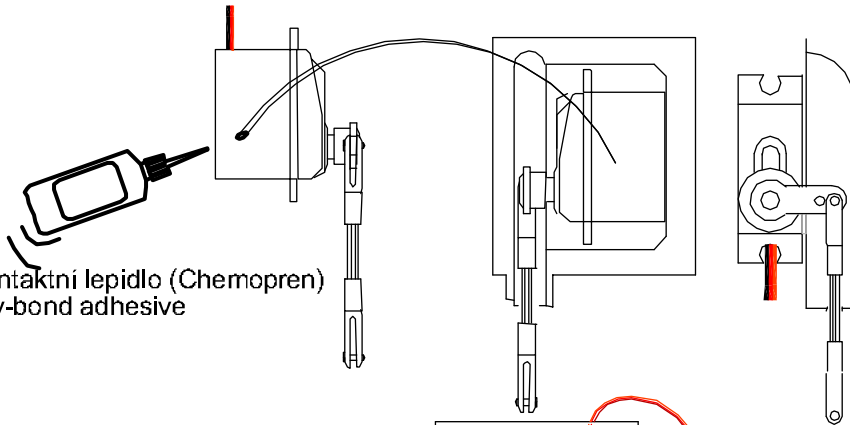

SPODNÍ STRANA
BOTTOM

2

SPODNÍ STRANA
BOTTOM

2

kontaktní lepidlo (Chemopren)
dry-bond adhesive

Pegasus

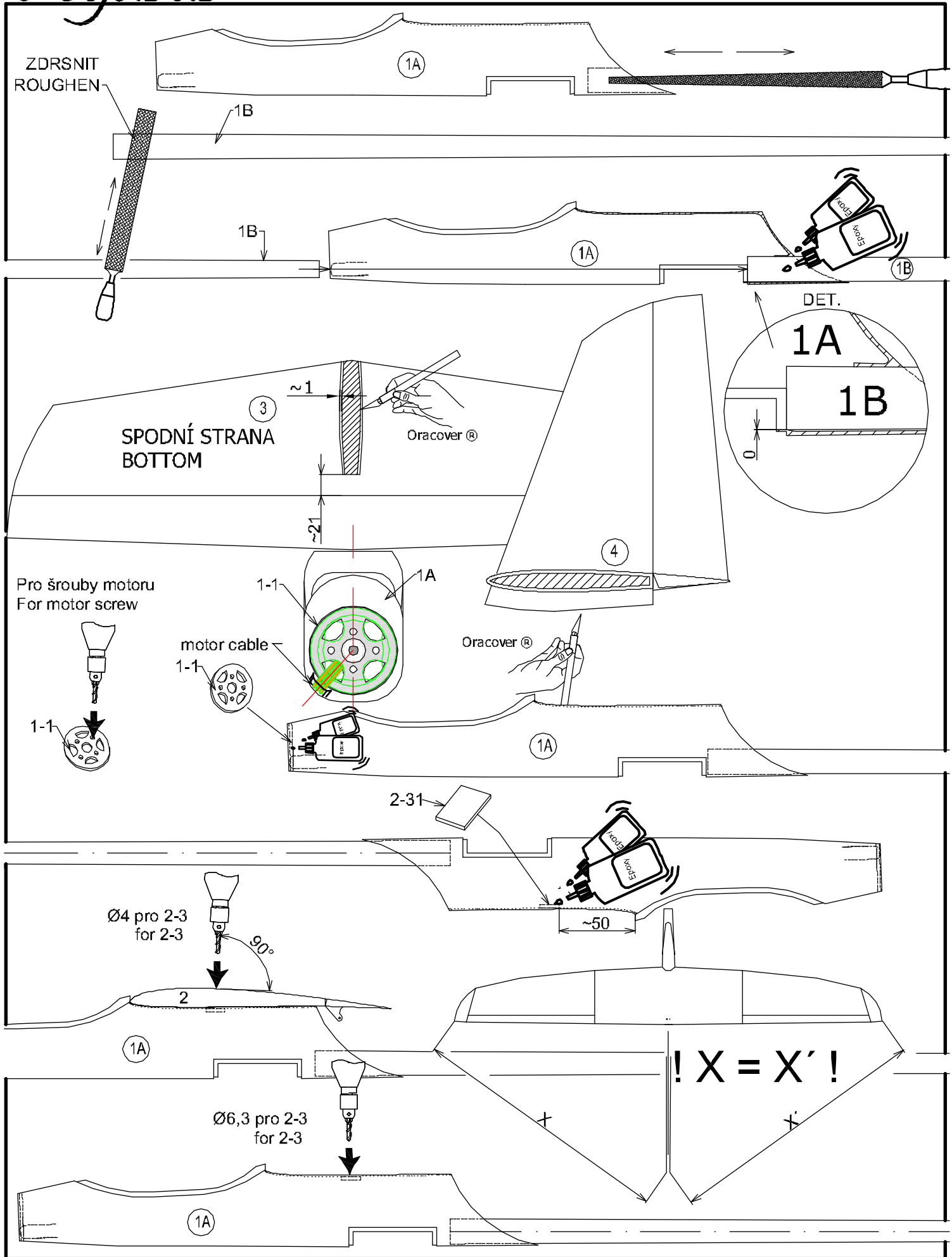

Pegasus

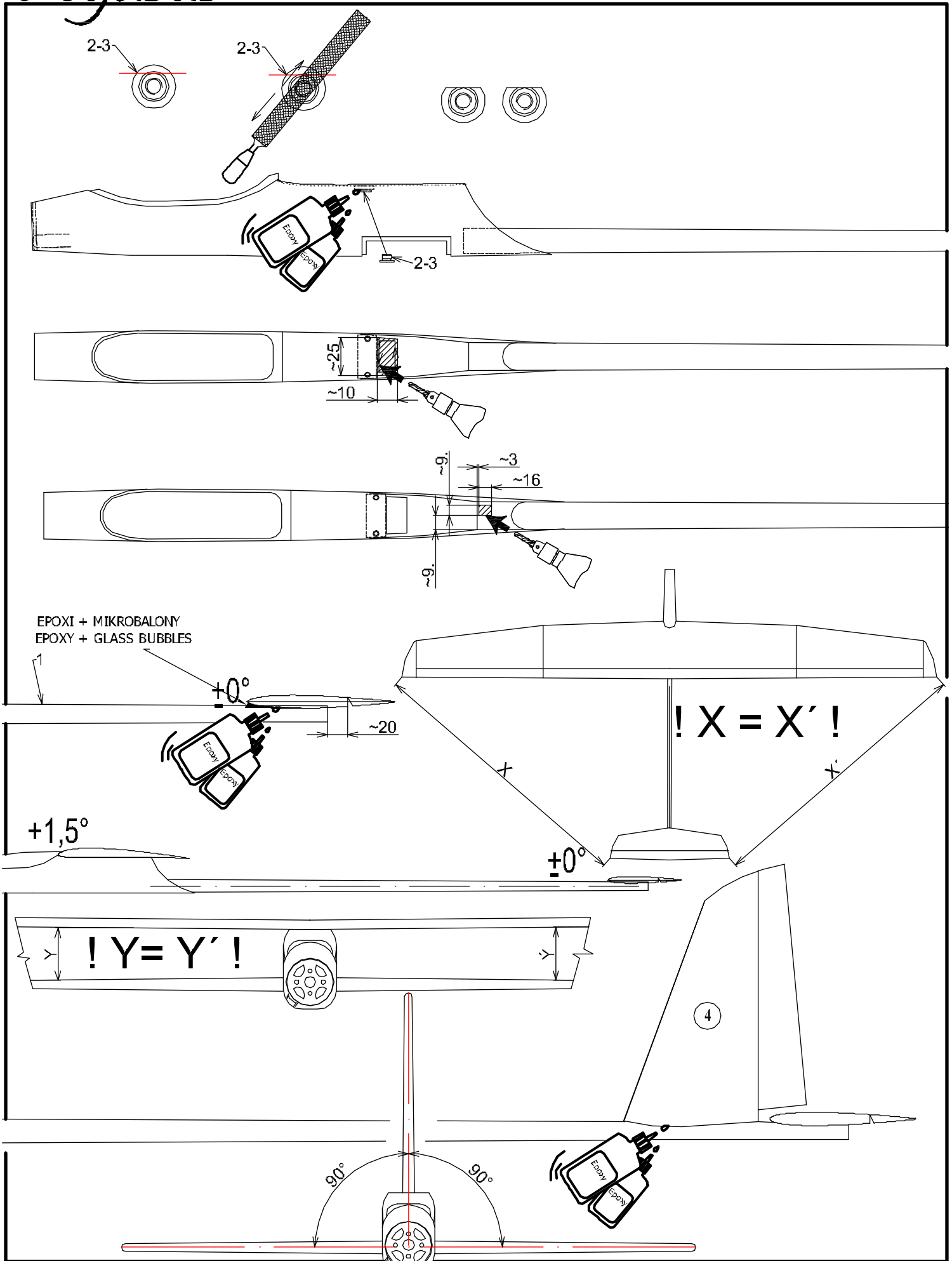

Pegasus

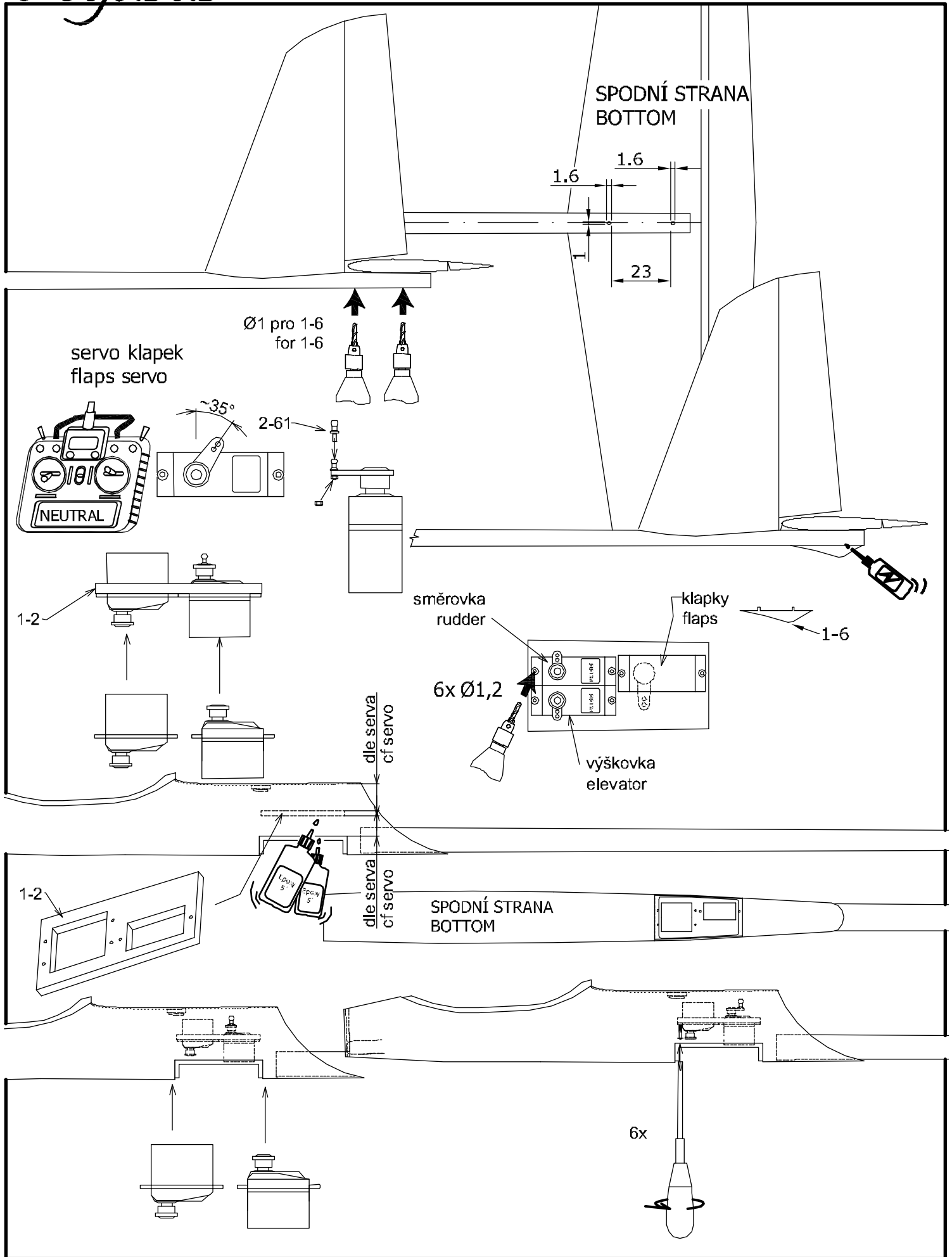

Pegasus

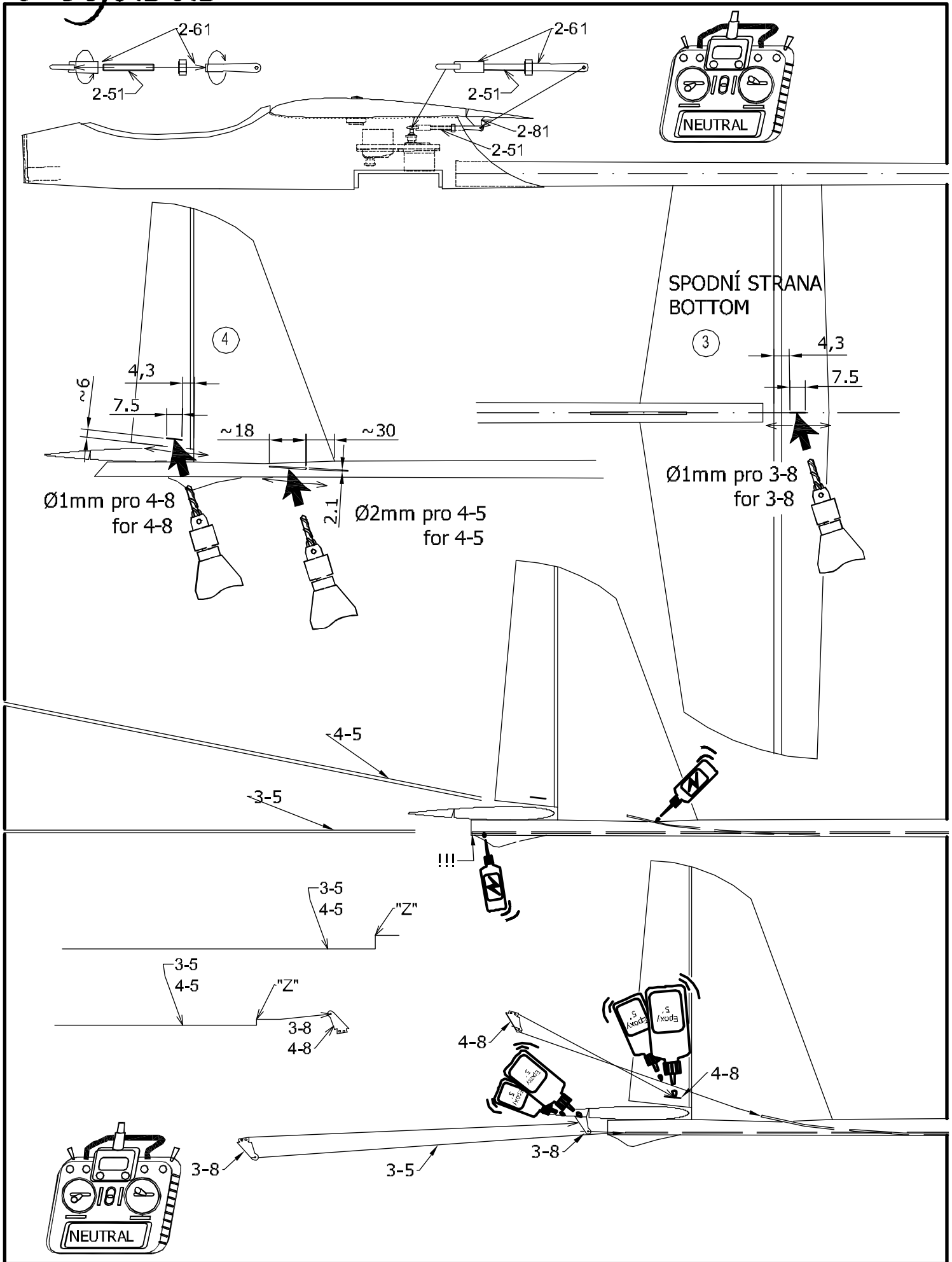

Pegasus

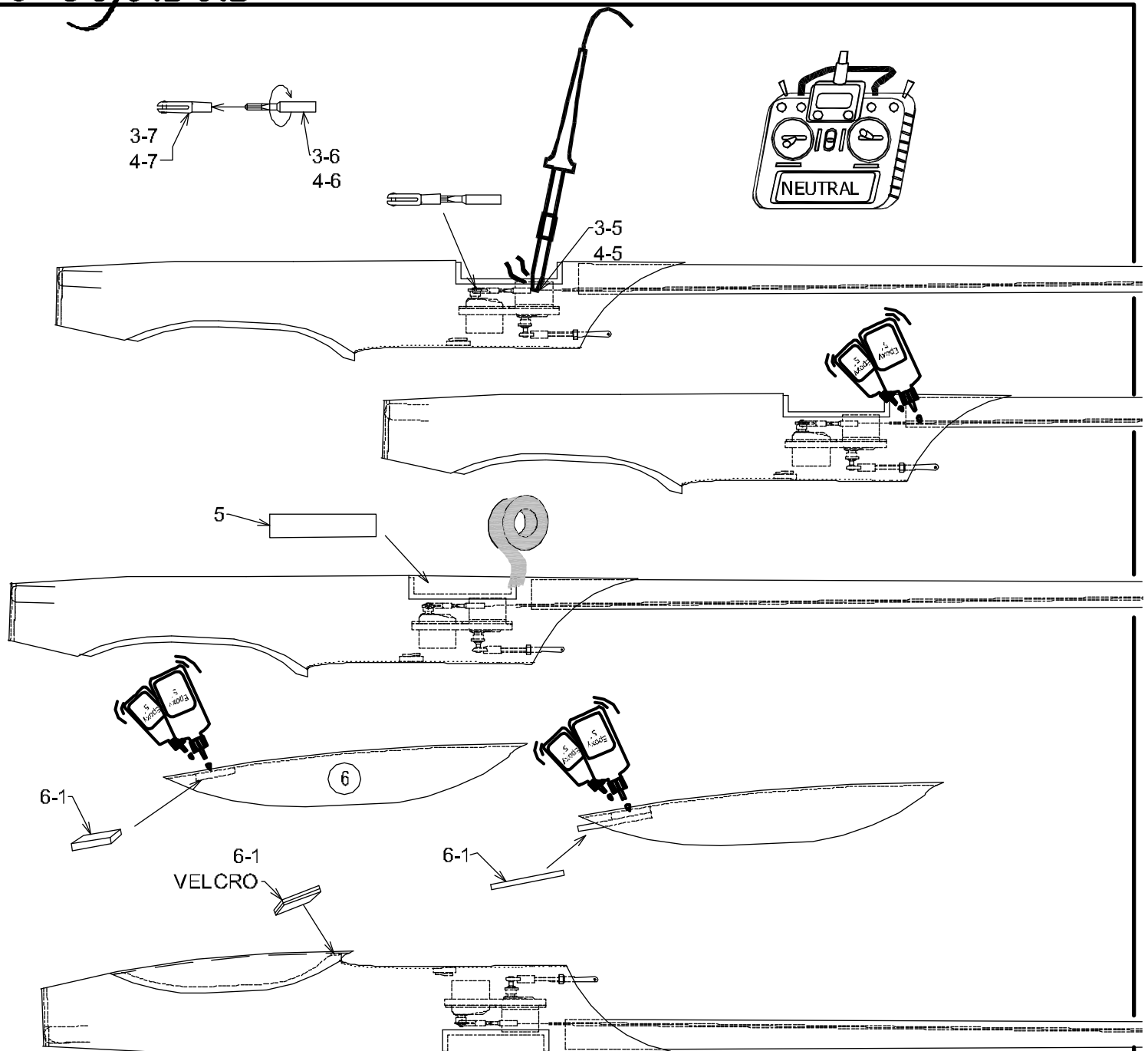

2 x prodlužovací kabel pro
serva křidélek
Flat extension cable 15cm
for ailerons servo 2 x

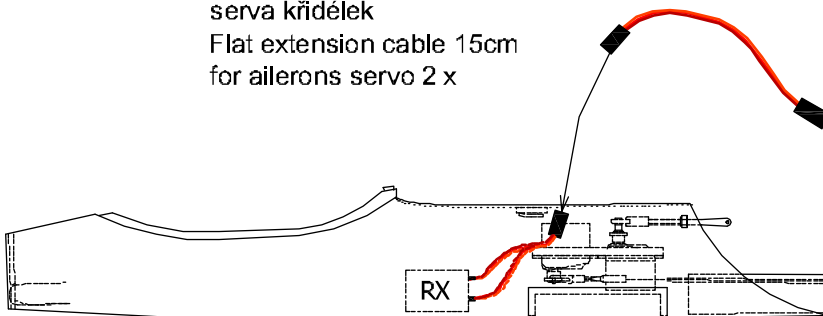

Pegasus

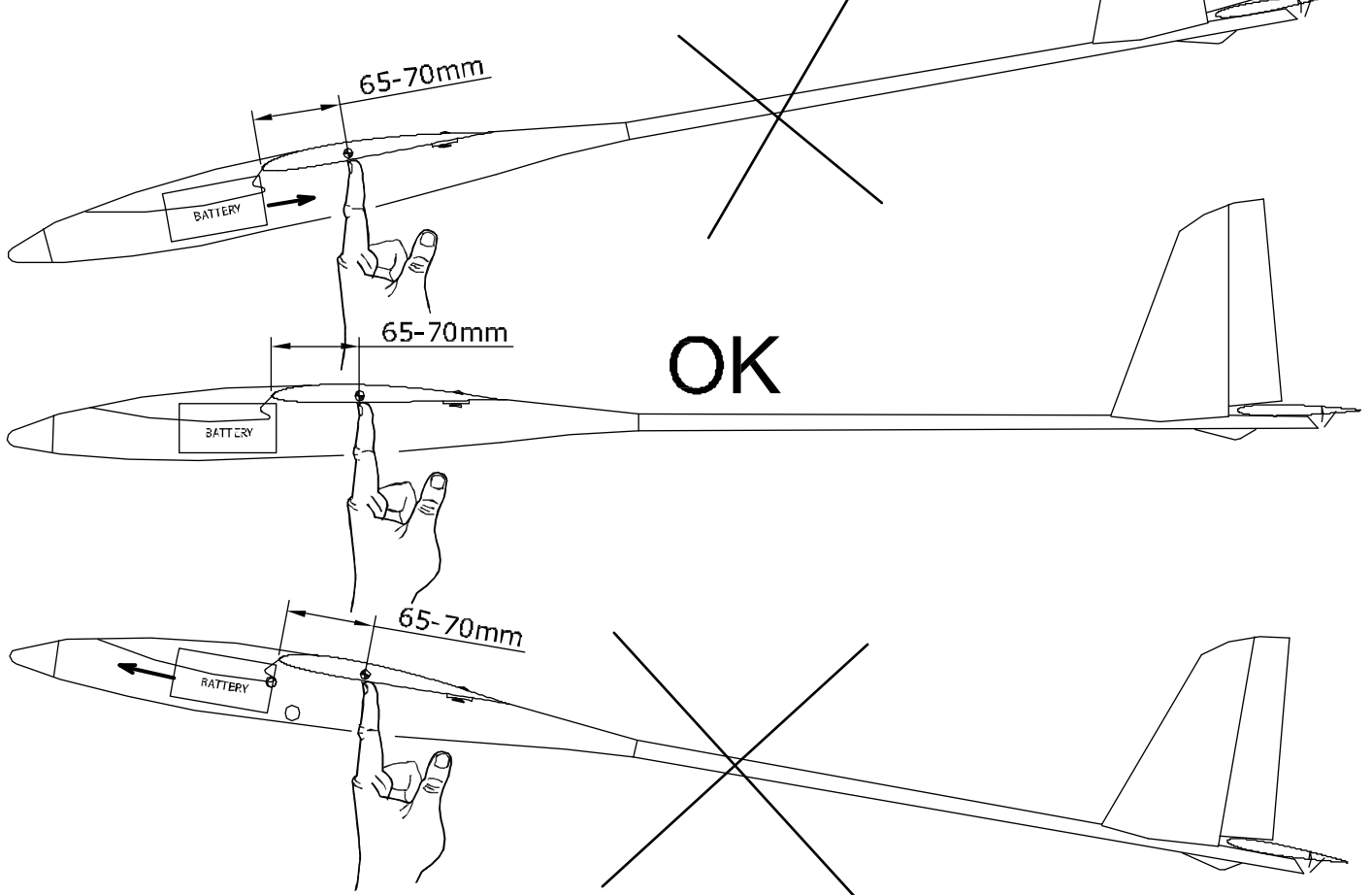
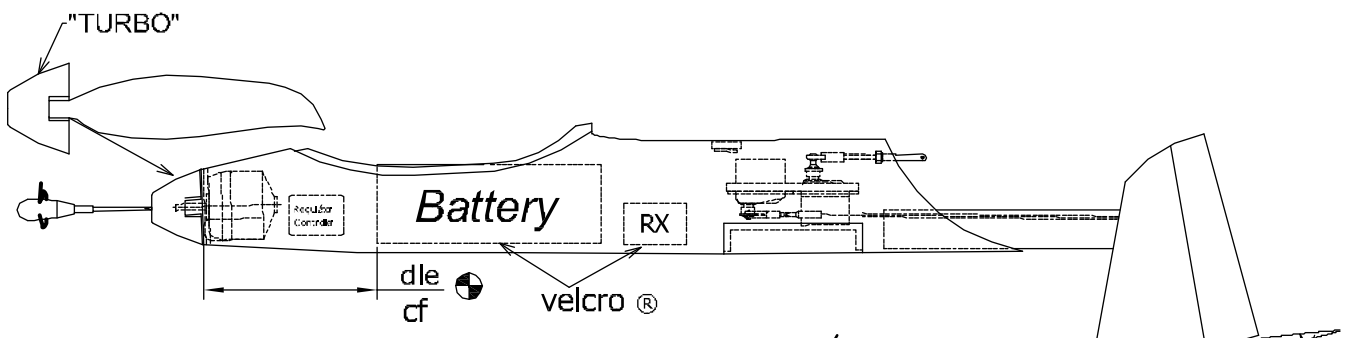
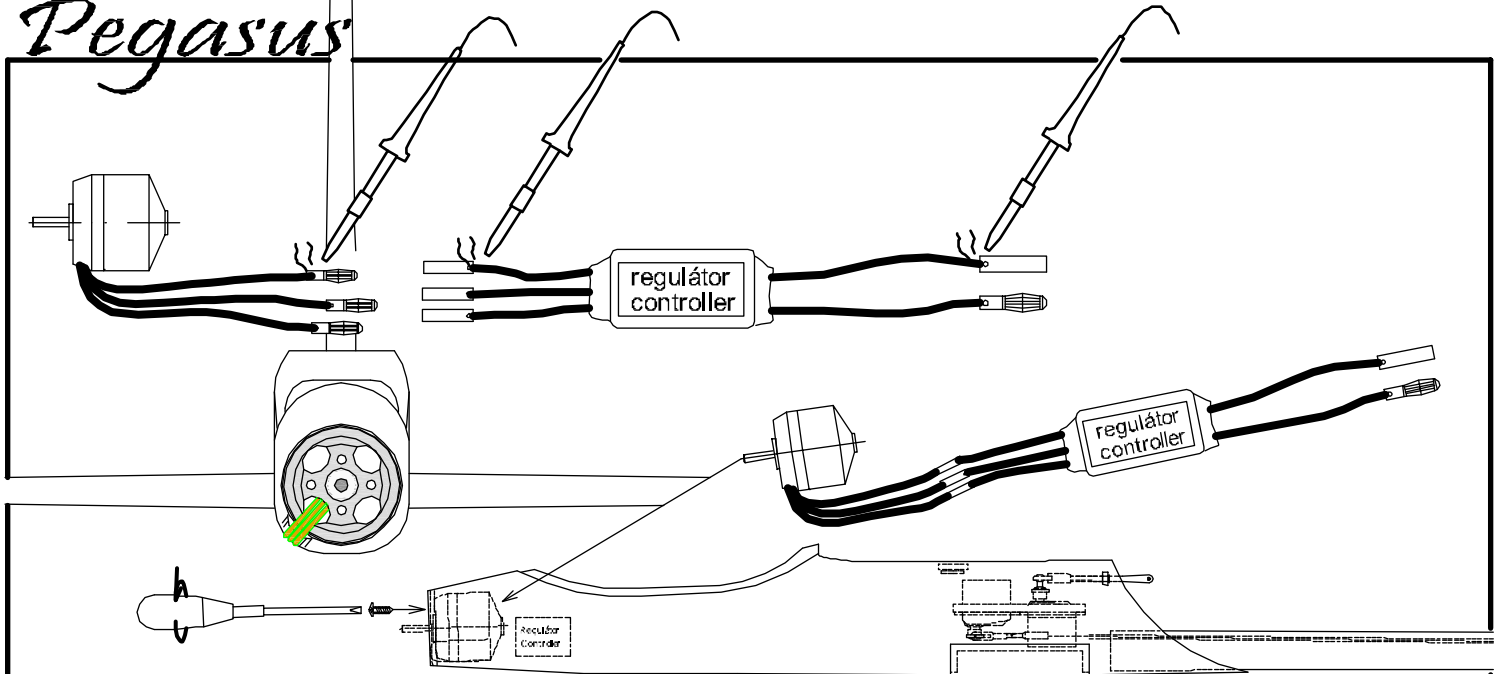

Pegasus

